

Plexo™ boxes IP 55 - IK 07

Dimensions

Cat.Nos 0 921 00/01

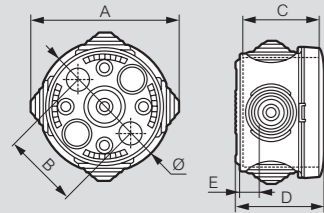

Cat.Nos	Ø	A	B	C	D	E
0 921 00	60	79	40	44.5	40	11
0 921 01	70	86	50	49.5	45	11

Cat.No 0 921 04

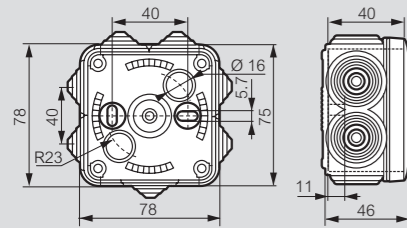

Plexo square boxes 130 x 130 mm Cat.Nos 0 920 32/34

Plexo rectangular boxes Cat.Nos 0 920 42/44/52/54/62/64/82/84/92/94

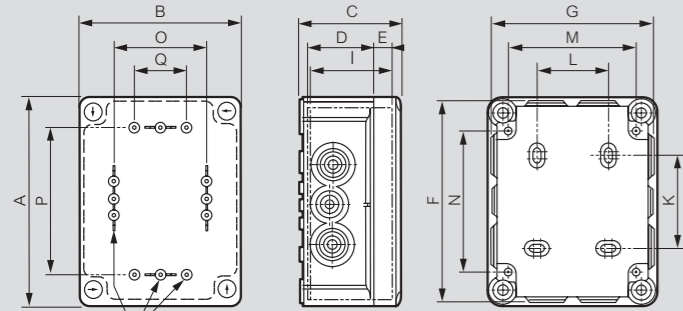

Fixing slots

Cat.Nos	Dimensions (mm)	A	B	F	G	C	D	E	I	Fixing of box				Fixing of accessories (screw Ø4 mm)		
										K	L	M	N	O	P	Q
0 920 32/34	130 x 130 x 74	150	150	149	149	81	56	18	67	54	70	120	103	106	106	84
0 920 42/44	155 x 110 x 74	175	130	173	128	81	56	18	67	79	50	100	128	86	131	64
0 920 52/54	180 x 140 x 86	200	160	205	165	94	69	18	80	104	50	130	153	116	156	94
0 920 62/64	220 x 170 x 86	240	190	245	195	94	69	18	80	144	80	160	193	146	196	124
0 920 82/84	310 x 240 x 124	332	262	340	270	132	97	27	116	220	160	222	276	200	260	150
0 920 92/94	360 x 270 x 124	382	292	390	300	132	97	27	116	270	190	252	326	230	310	150

Cat.Nos 0 921 26/27

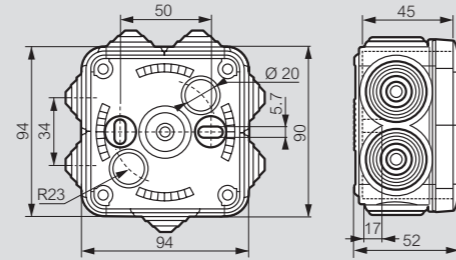

Cat.Nos 0 921 36/37

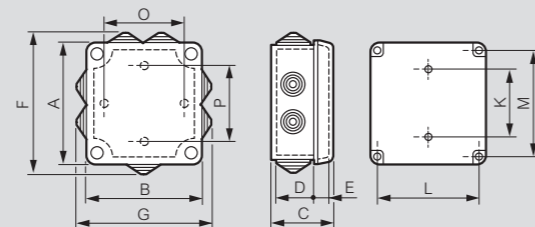

Cat.Nos	A	B	F	G	C	D	E	Fixing of box			S dm²	Fixing of accessories (screw Ø4 mm)	
								K	L	M		O	P
0 921 36	116	116	132	132	60	41.8	13.4	50	95	95	1.34	80	80
0 921 37	116	116	121	121	60	41.8	13.4	50	95	95	1.34	80	80

Technical characteristics

Additional regulation

In accordance with European directive RoHS (2002/95/CE modified by decision 2005/618/CE) and with its FAQ "guidance for EEE directives", widened to all halogenated flame retardants, Plexo boxes (Cat.Nos mentioned below) don't contain halogenated flame retardant: 0 920 32/0 920 42/0 920 44/0 920 52/0 920 62/0 920 82/0 921 26/0 921 36

Equipment with terminal blocks

Boxes (mm)	Bare terminal blocks on support and IP 2X blocks						Max. number of Nybloc auto terminal support
	4 holes	8 holes	13 holes	17 holes	22 holes	35 holes	
130 x 130 x 74	•	•					4
155 x 110 x 74	•	•	•				4
180 x 140 x 86	•	•	•				6
220 x 170 x 86	•	•	•	•	•		10
310 x 240 x 124	•	•	•	•	•	•	10
360 x 270 x 124	•	•	•	•	•	•	10

Spare membrane glands for Plexo boxes

• Direct entry

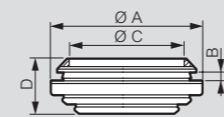

• To be cut

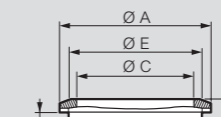

	A (mm)	B (mm)	C (mm)	D (mm)	E (mm)
Ø20	Ø27.6	2	Ø20	10	Ø22
Ø25	Ø33.8	2	Ø25	12.8	Ø27.5
Ø32	Ø42	2	Ø32.2	14.5	Ø34.6
Ø40	Ø50	2	Ø40.2	16.2	Ø42.5

	A (mm)	B (mm)	C (mm)	D (mm)	E (mm)
Ø20	Ø27.6	2.4	Ø20.2	15.5	Ø22
Ø25	Ø33.8	2.4	Ø25.6	18	Ø27.5

User of membrane glands per type of boxes

Boxes	Membrane glands			
	Ø20	Ø25	Ø32	Ø40
Round				
Ø60	4			
Ø70	4			
Square				
65 x 65 x 40	7			
80 x 80 x 45	7			
105 x 105 x 55		7		
130 x 130 x 74	2	8		
Rectangular				
155 x 110 x 74	2	8		
180 x 140 x 86		4	6	
220 x 170 x 86		8	6	
310 x 240 x 124			18	6
360 x 270 x 124			16	8